

LEGENDA

- 377 POZEMKOVÉ PARCELY, PARCELNÍ ČÍSLA
- ŘEŠENÝ OBJEKT
- NOVÉ PŘÍSTAVBY
- STÁVAJÍCÍ OBJEKTY

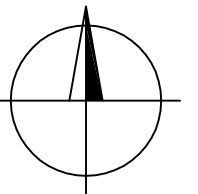

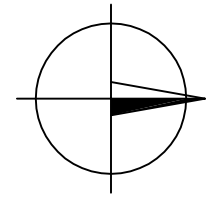
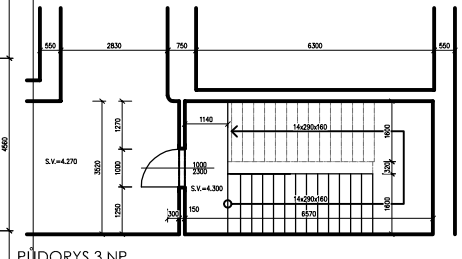
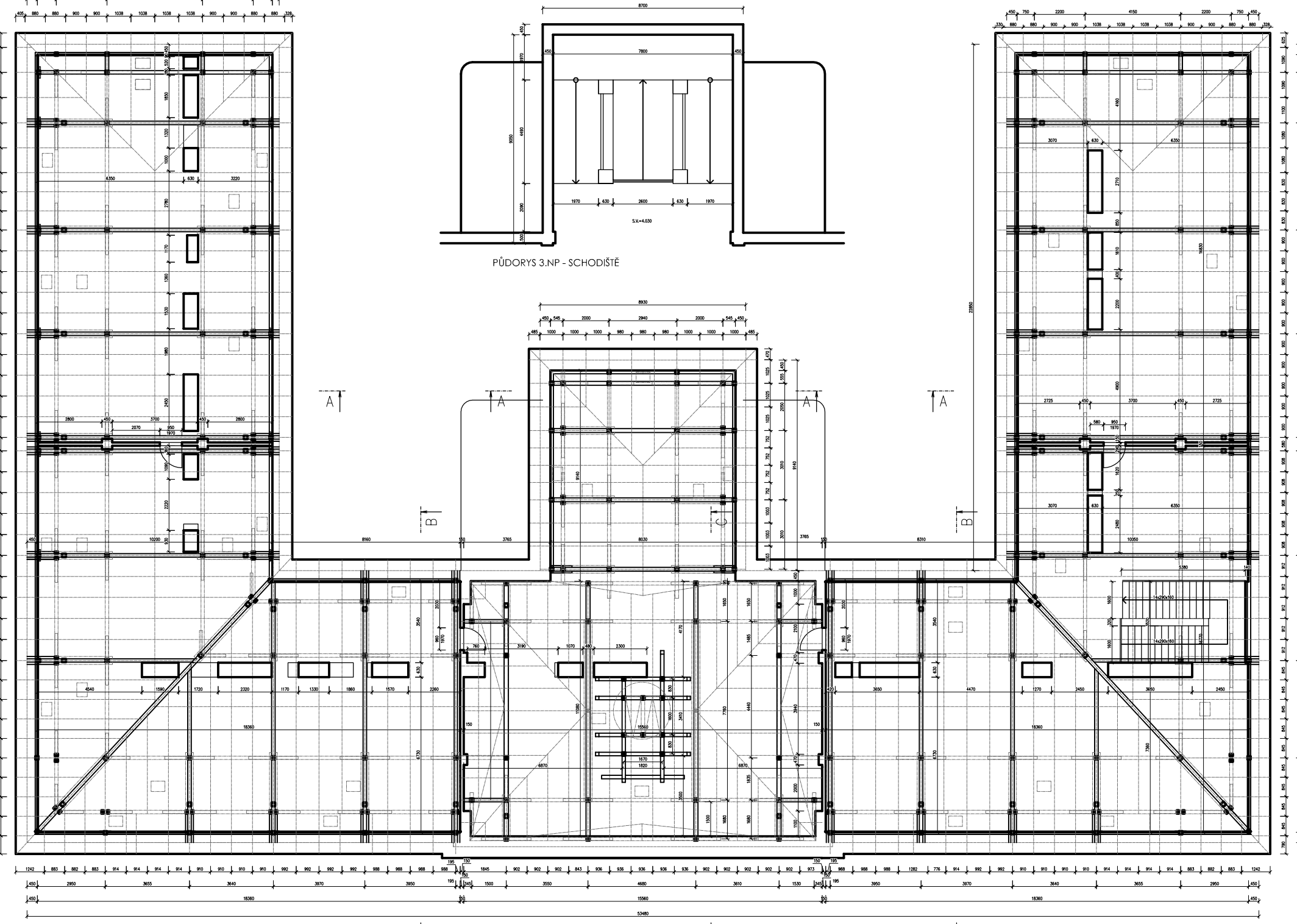
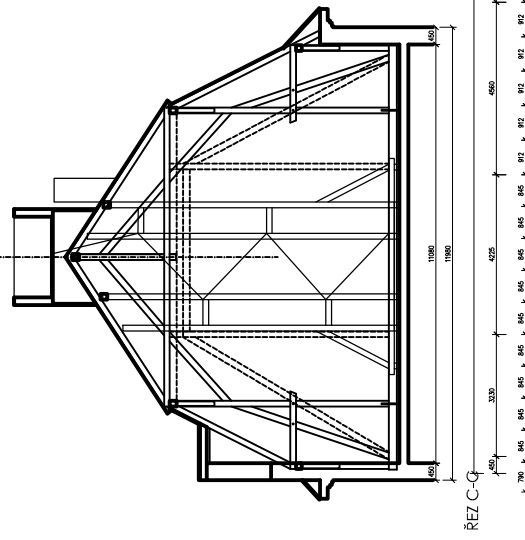
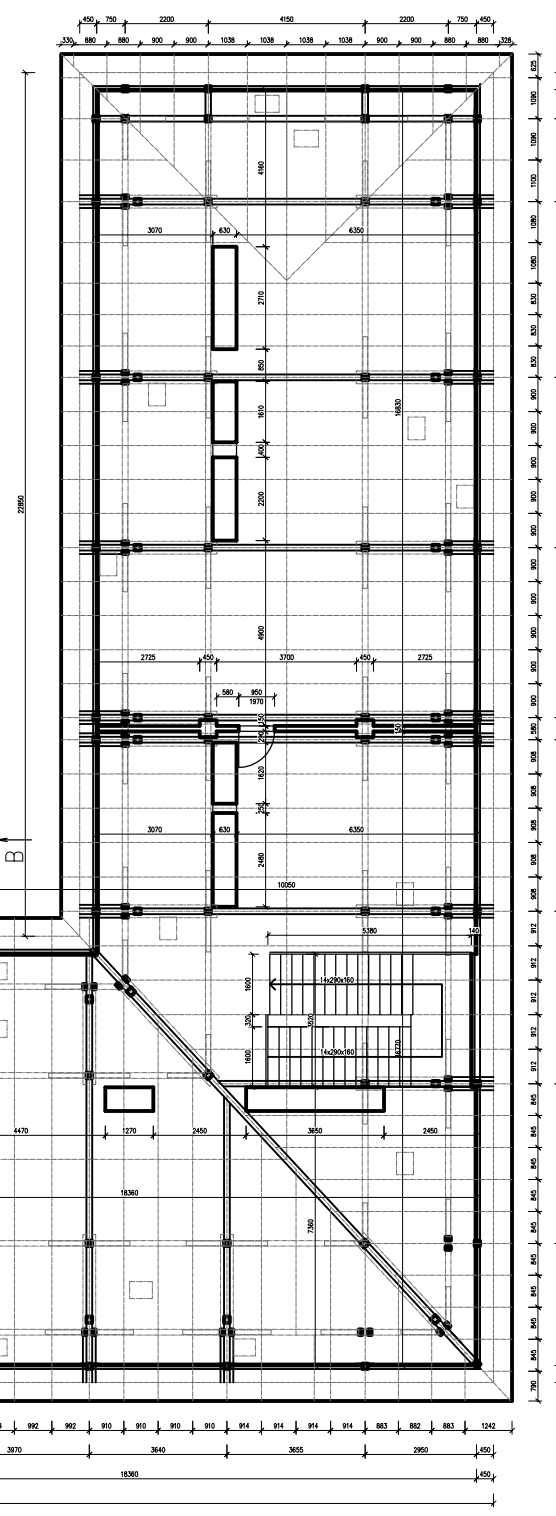
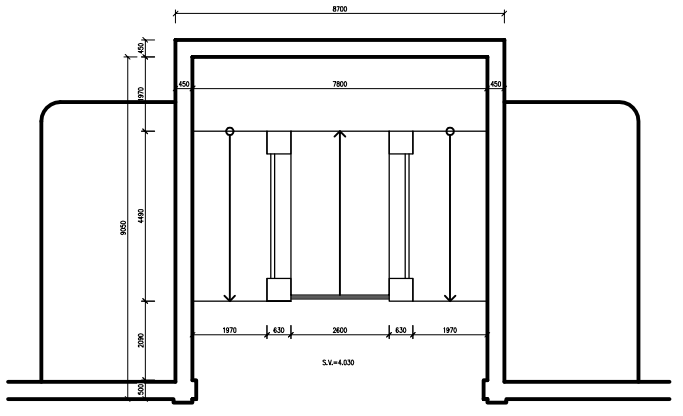
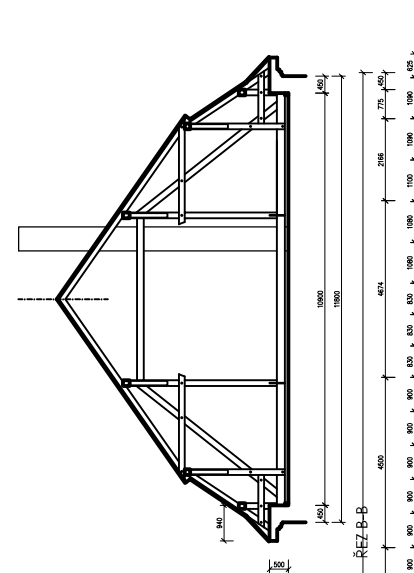
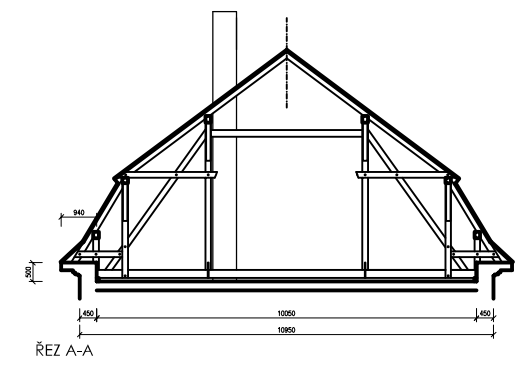
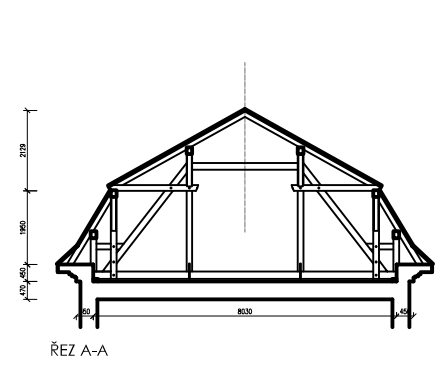
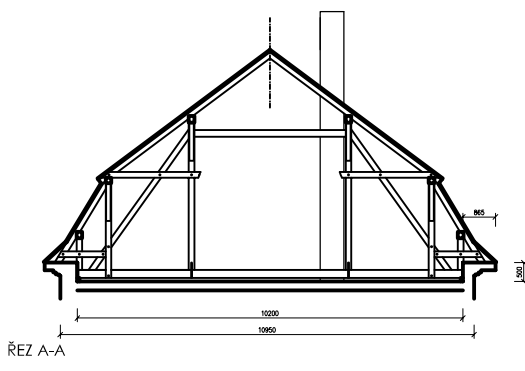

**POZNÁMKY :**  
 - zaměření objektu bylo zpracováno na základě původní archívni dokumentace, měření na místě (laserový měřič Bosch GLM 40 a ruční metry) a dopočtem  
 - veškeré rozměry je vždy nutné ověřit na místě!

±0,00=podlaha podkroví  
 kótováno v mm

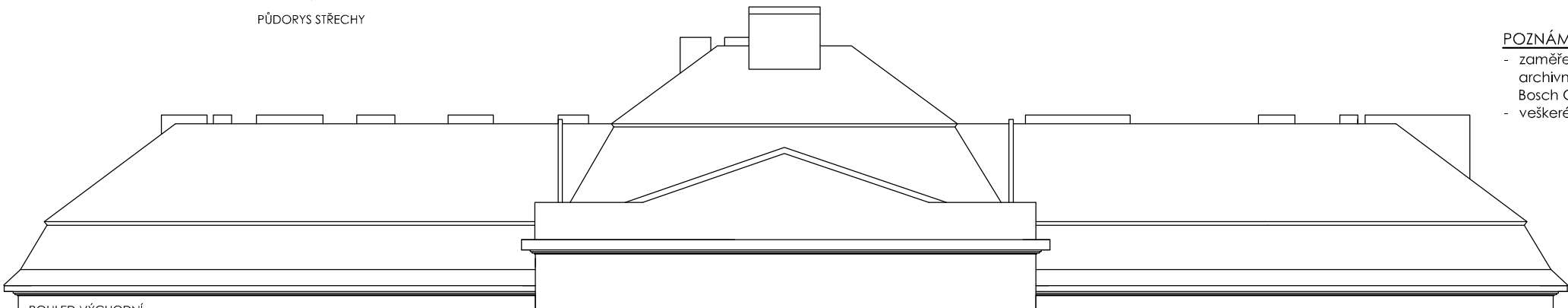
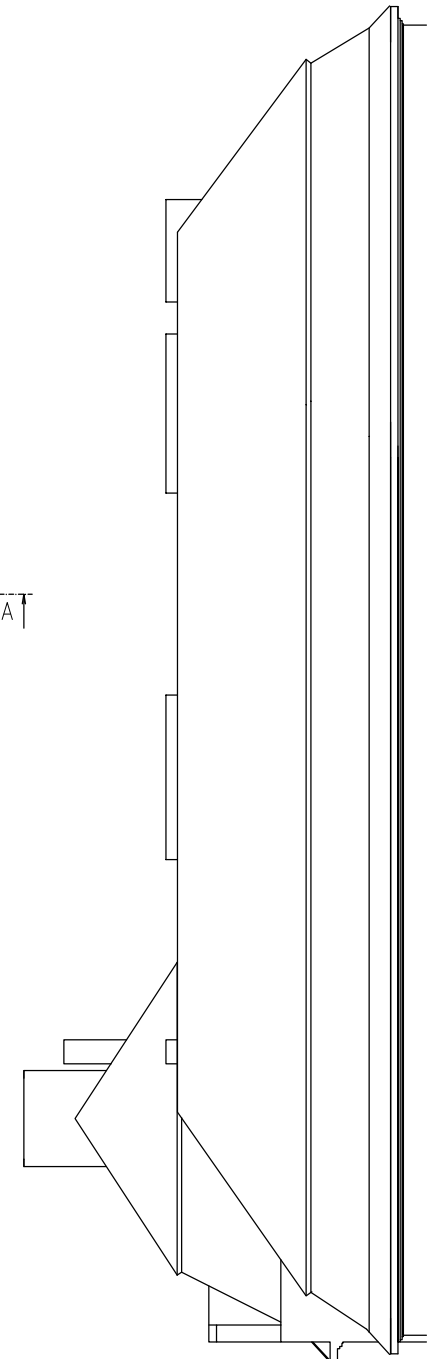
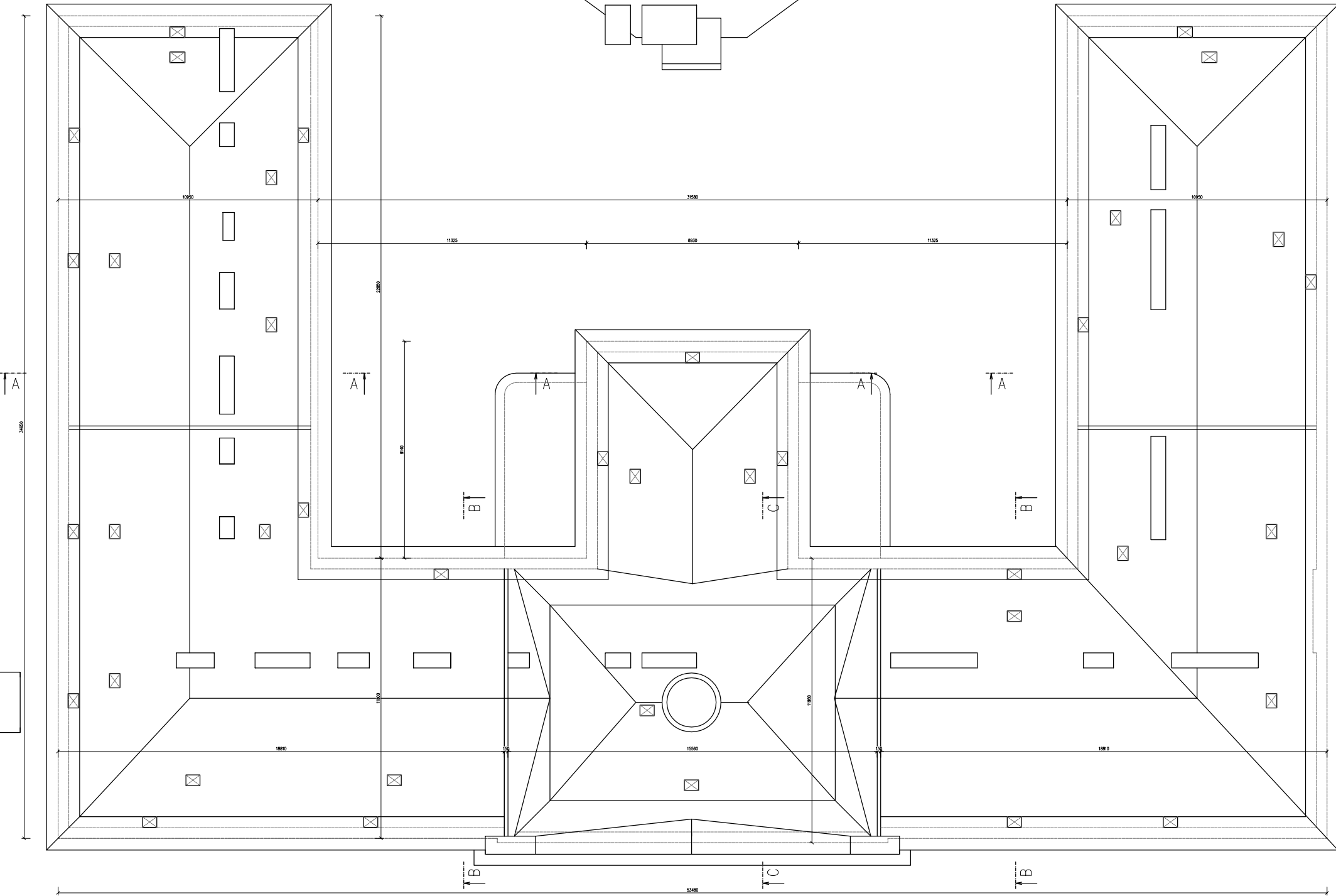
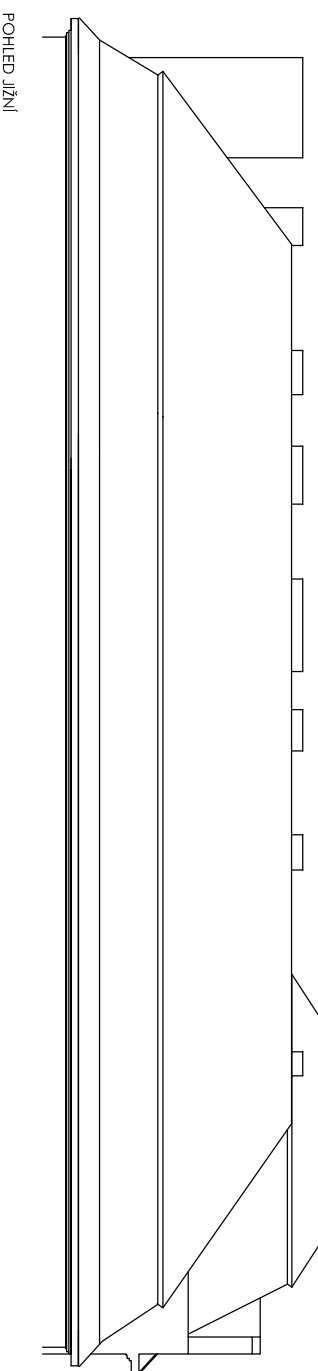
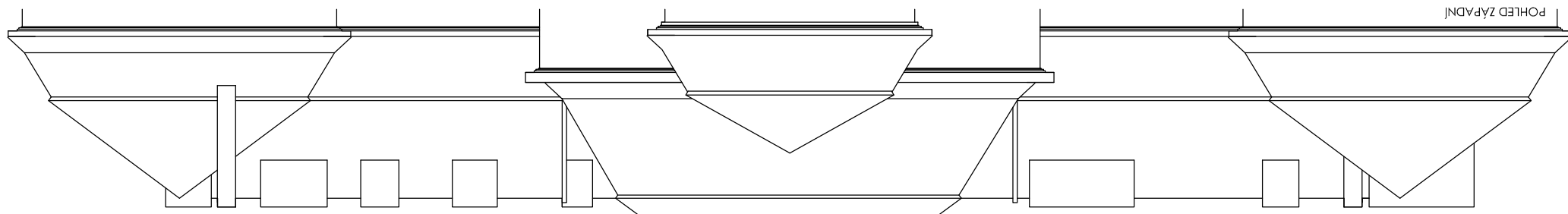

**POZNÁMKY :**  
 - zaměření objektu bylo zpracováno na základě původní archivní dokumentace, měření na místě (laserový měřič Bosch GLM 40 a ruční metry) a dopočtem  
 - veškeré rozměry je vždy nutné ověřit na místě!

±0,00=podlaha podkroví  
 kótováno v mm

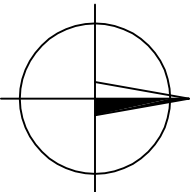

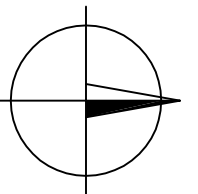
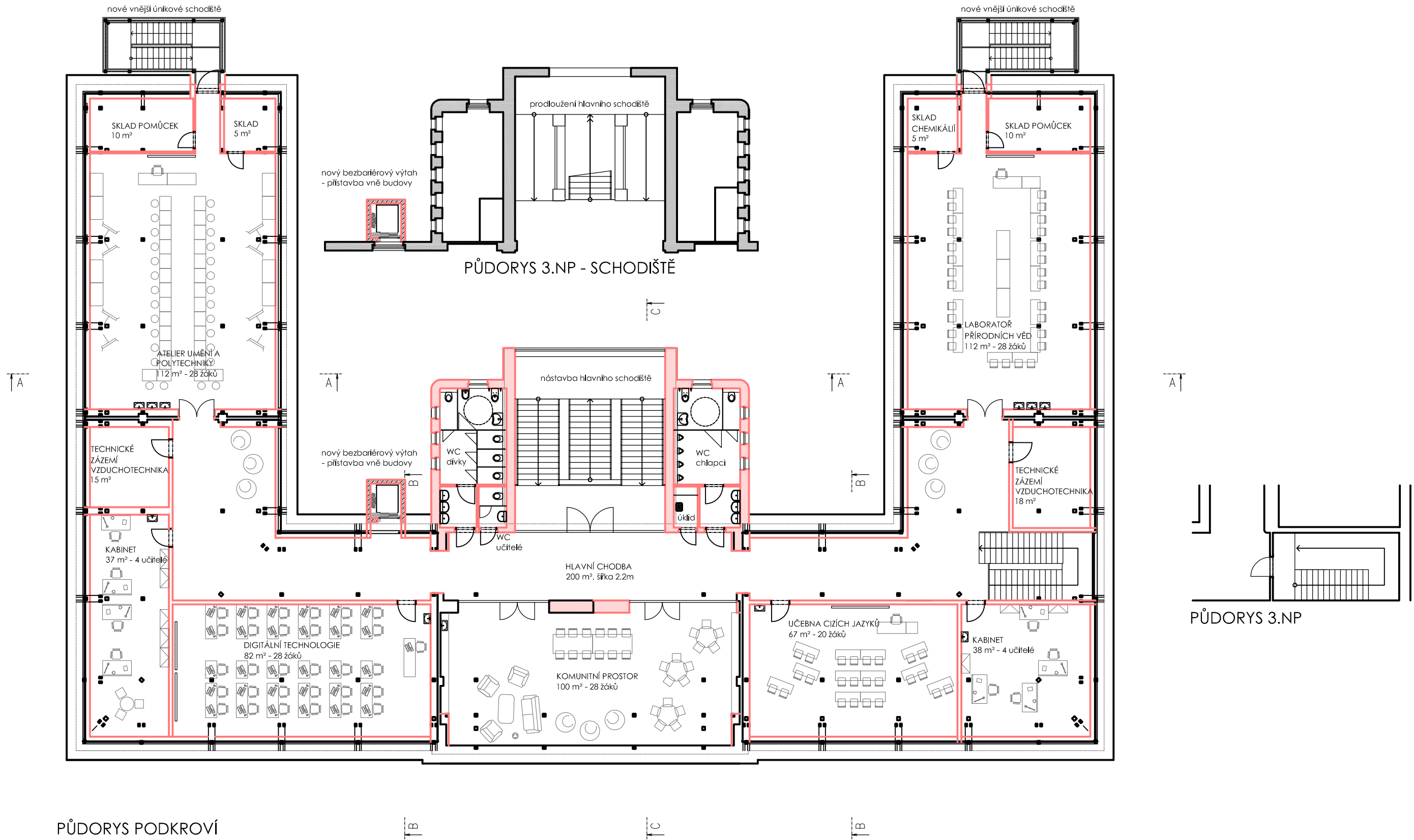

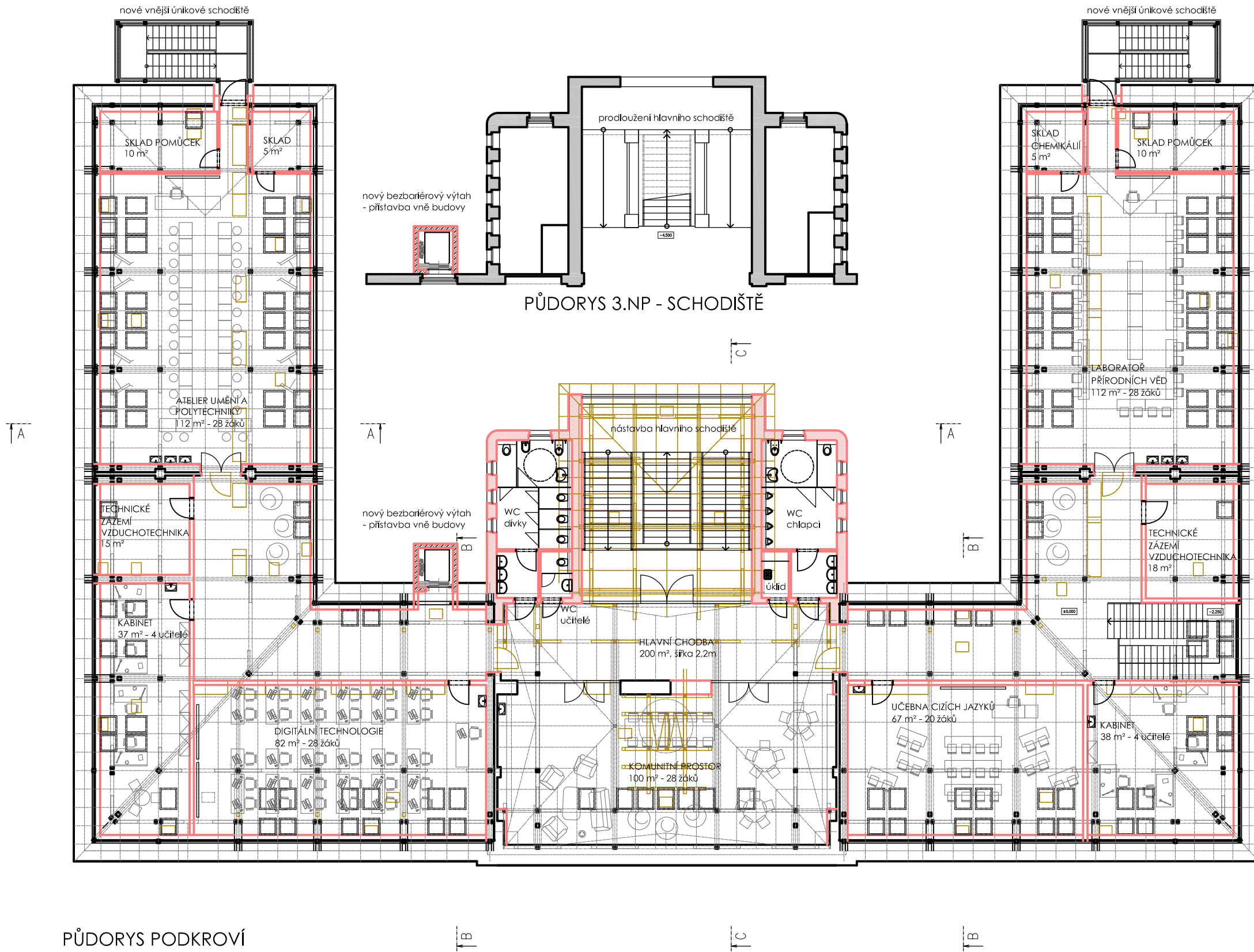

- LEGENDA MATERIÁLŮ**
- STÁVAJÍCÍ KONSTRUKCE
  - BOURANÉ KONSTRUKCE
  - NOVÉ KONSTRUKCE

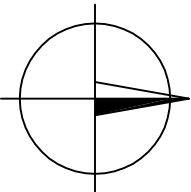



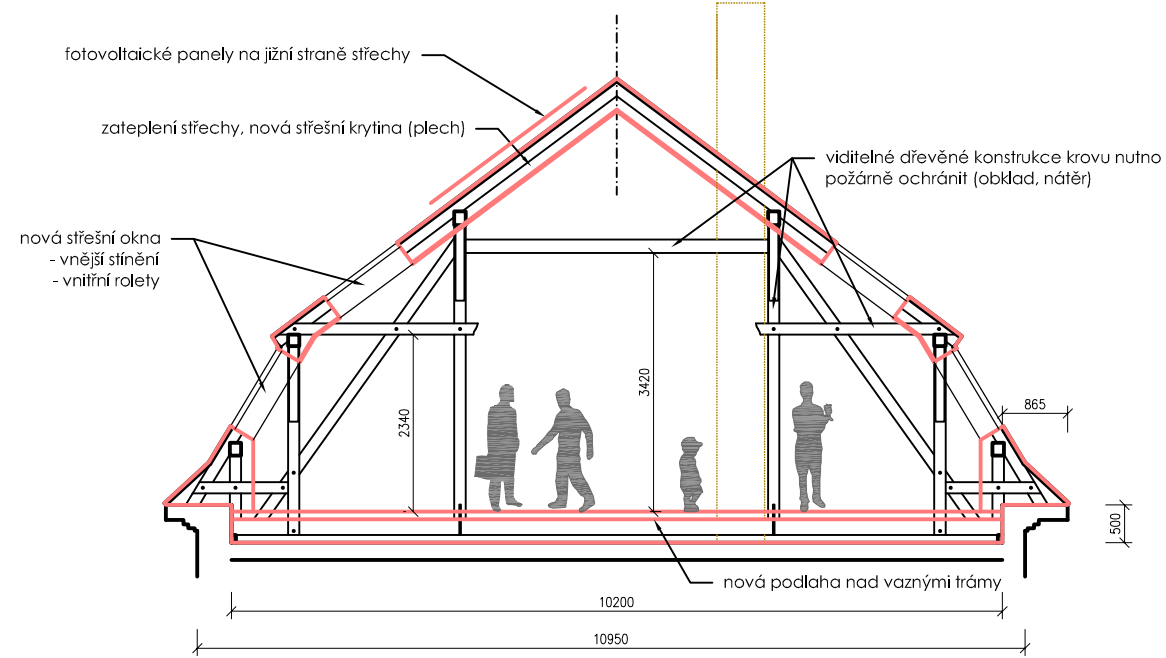

ŘEZ A-A

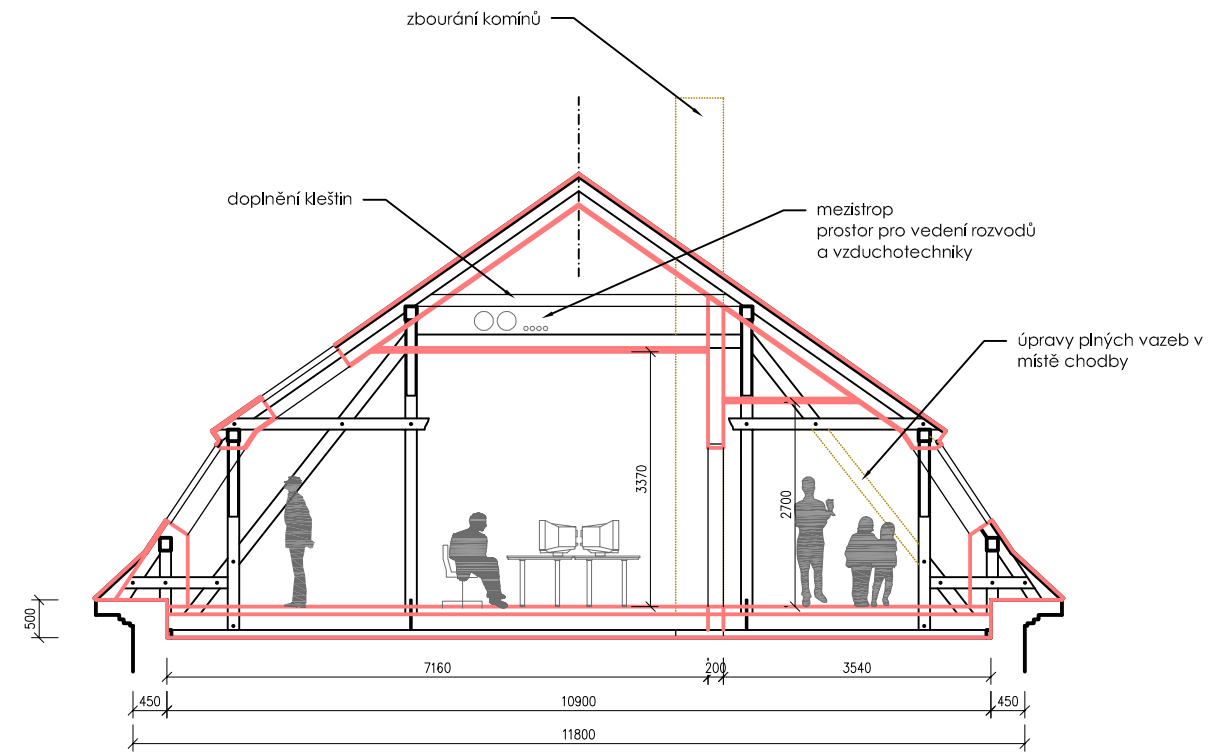

ŘEZ B-B

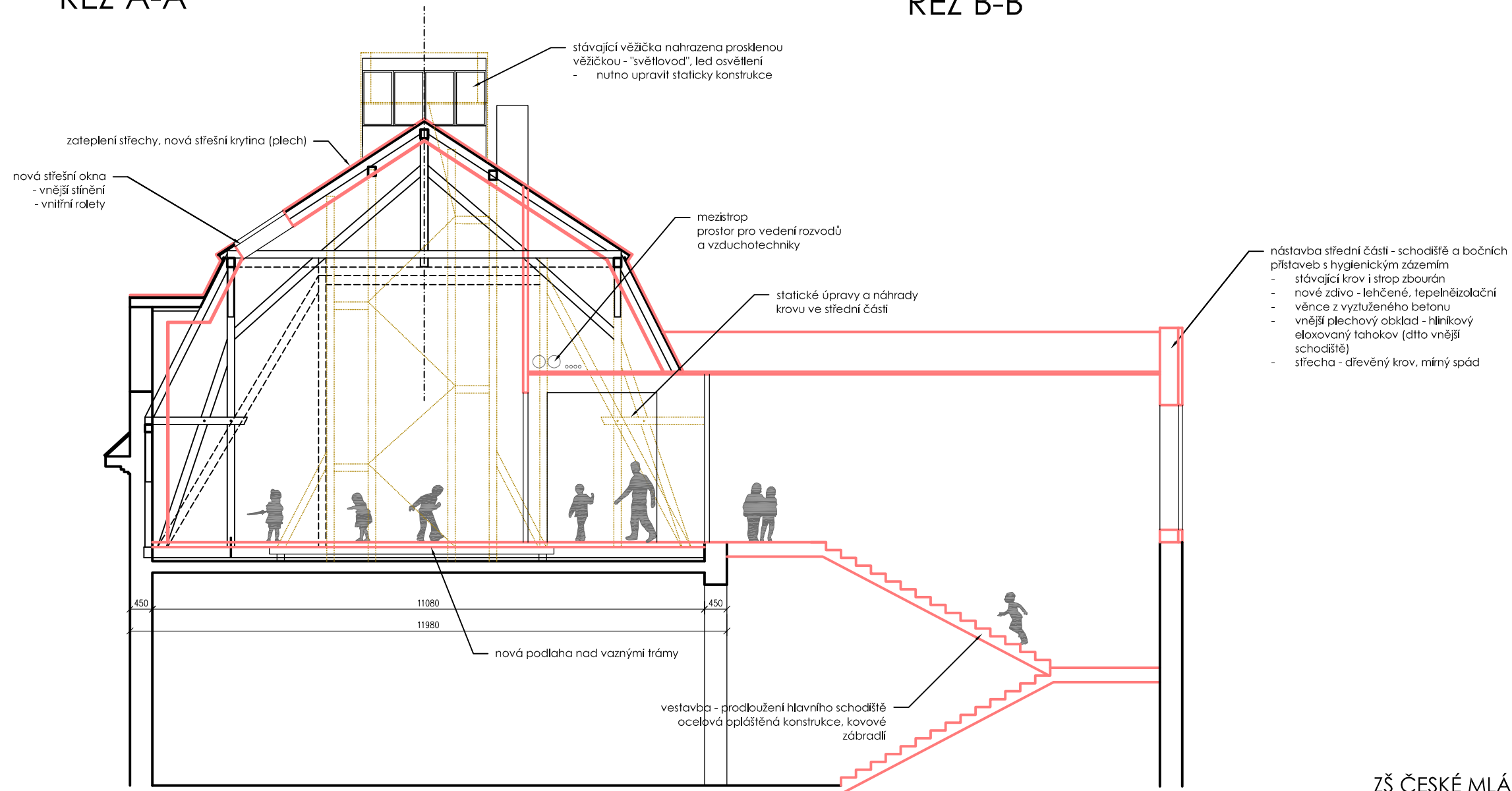

ŘEZ C-C

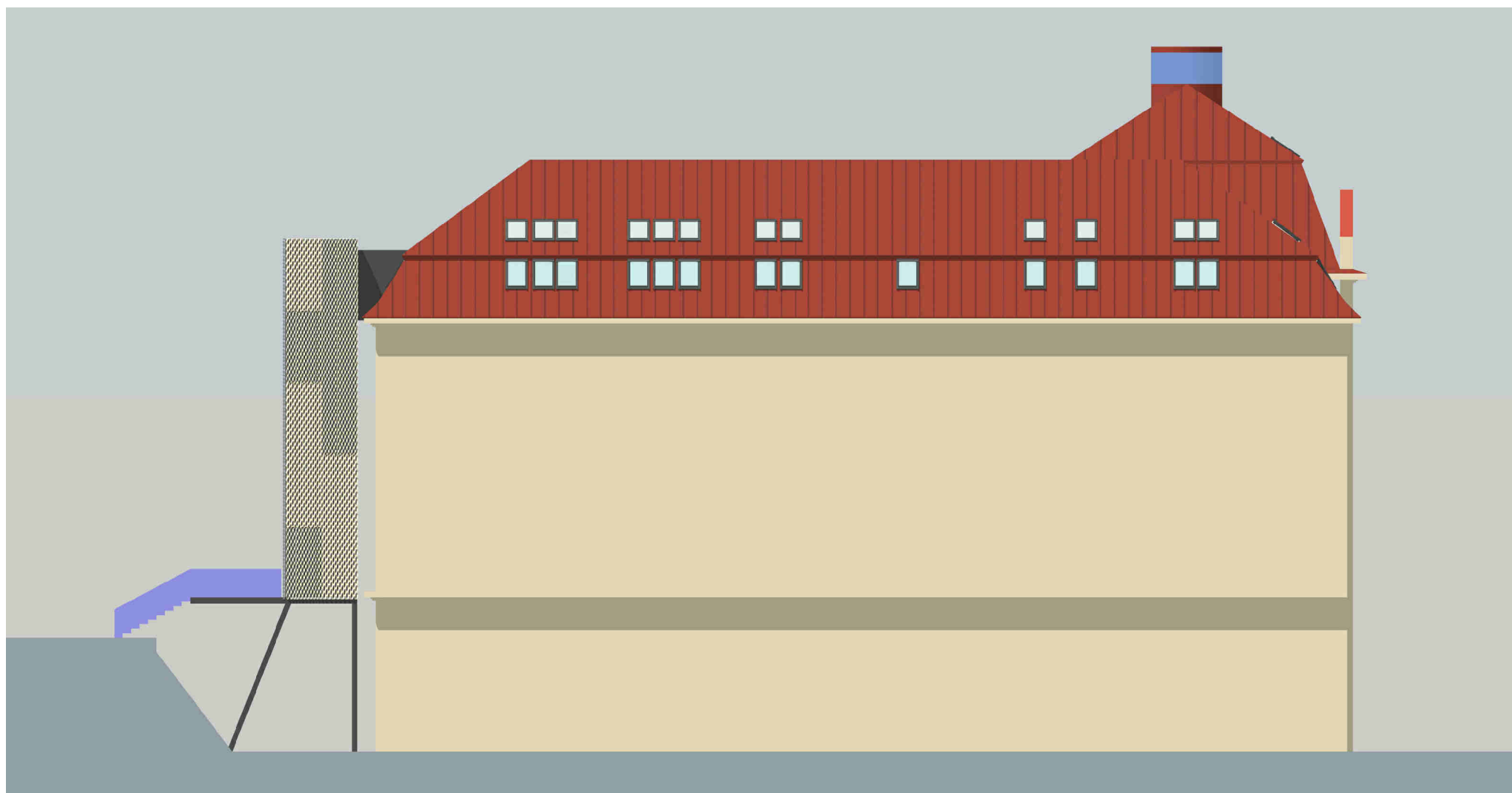

POHLED JIŽNÍ

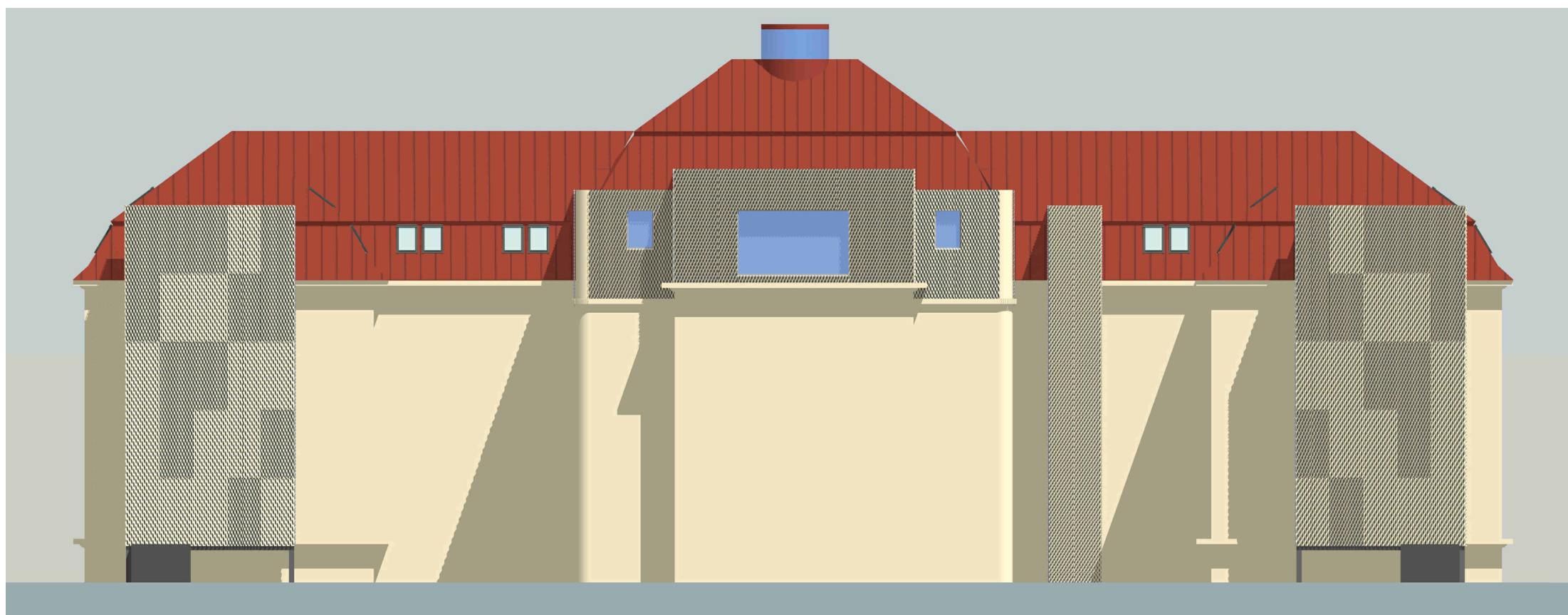

POHLED ZÁPADNÍ

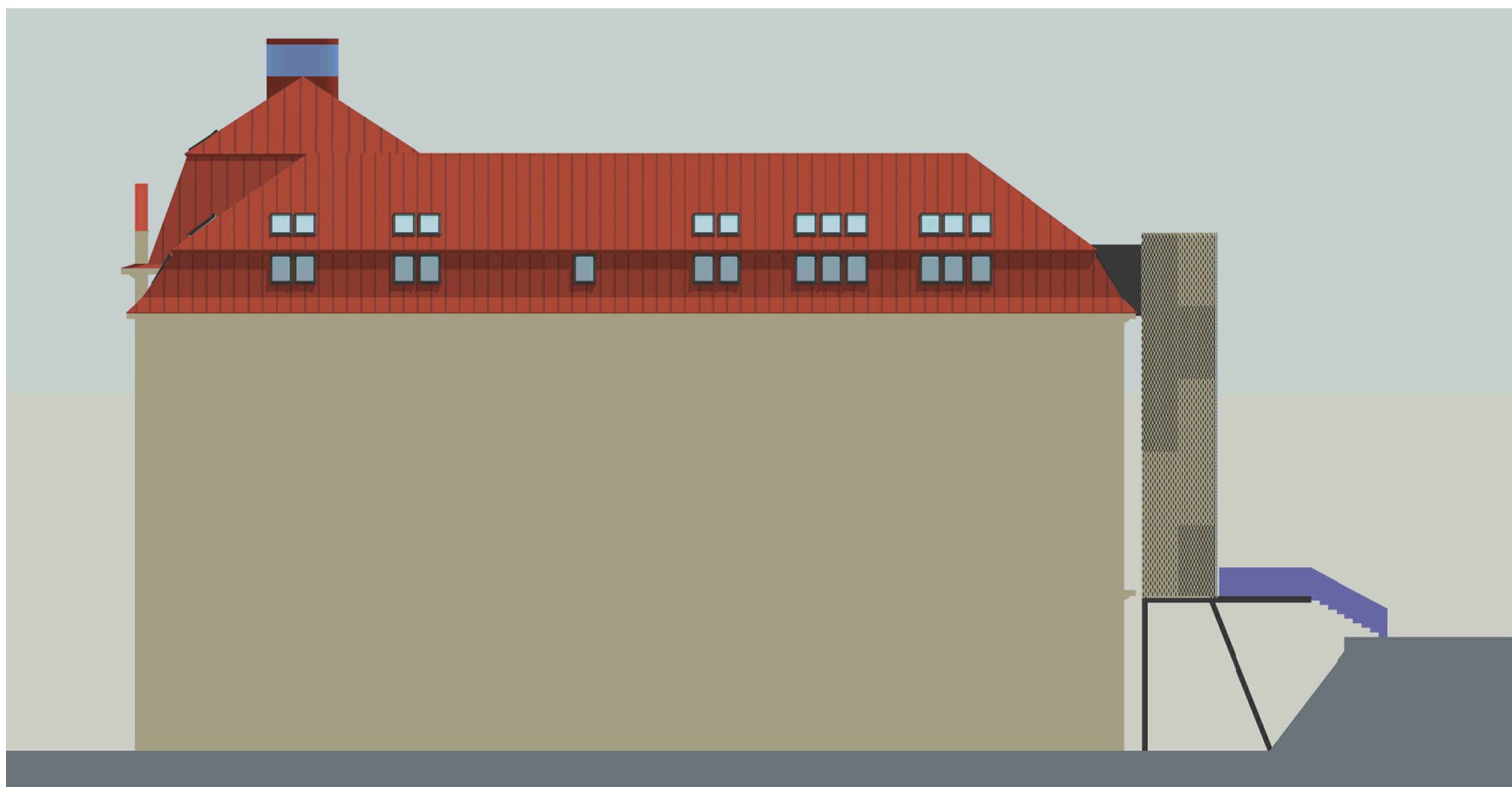

POHLED SEVERNÍ

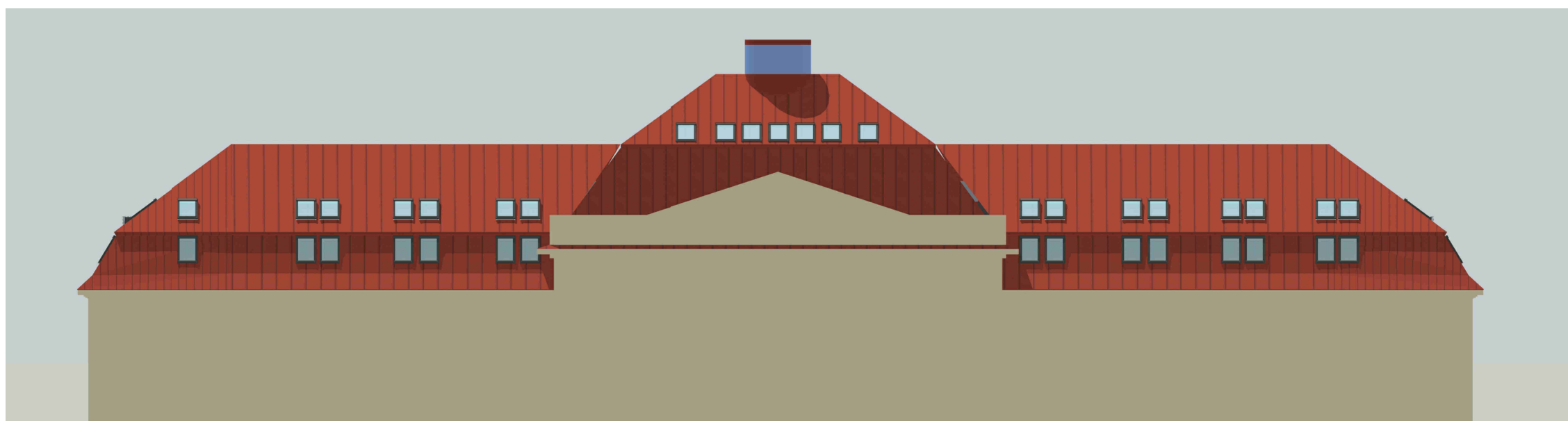

POHLED VÝCHODNÍ



